

40 Litre Floor Standing Mixer

HSM40SS-F1E

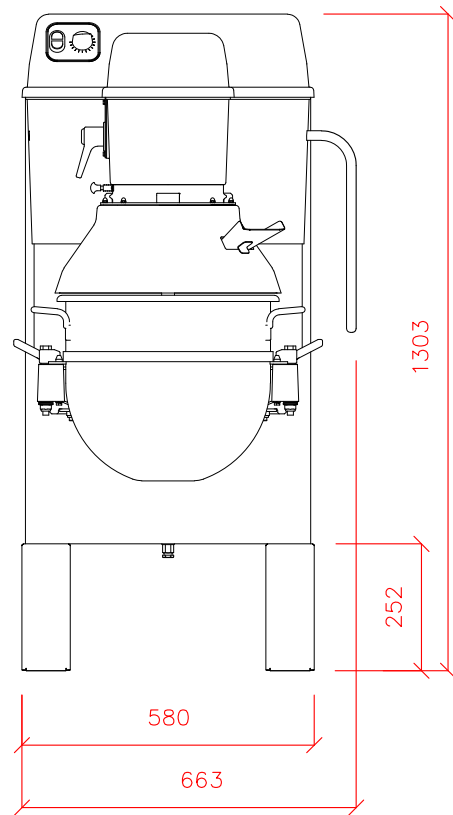

View on 'A'

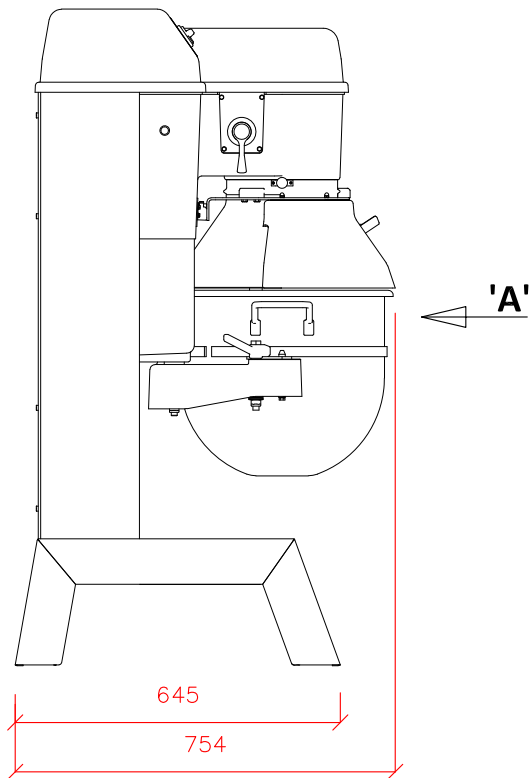
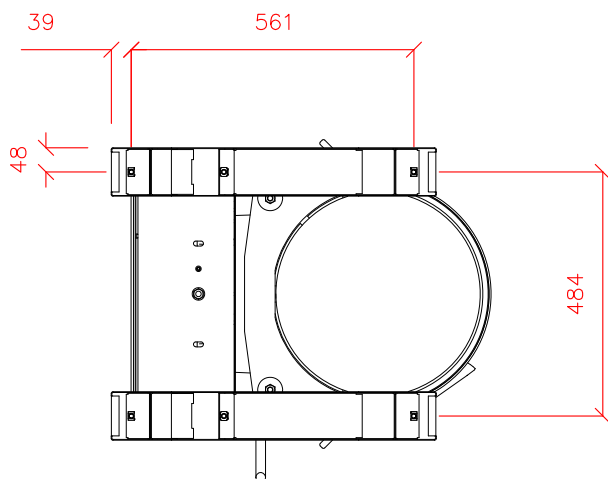

View on 'B'



1 Electric - (1 Phase Supply)
1.1kW - 230/50/1 Recommended to be fused at 20amps

2 Weight
Mixer weight including agitator and bowl (empty) - 205kg
Shipping weight (on wooden pallet). - 223kg